

L21/31, L21/31S

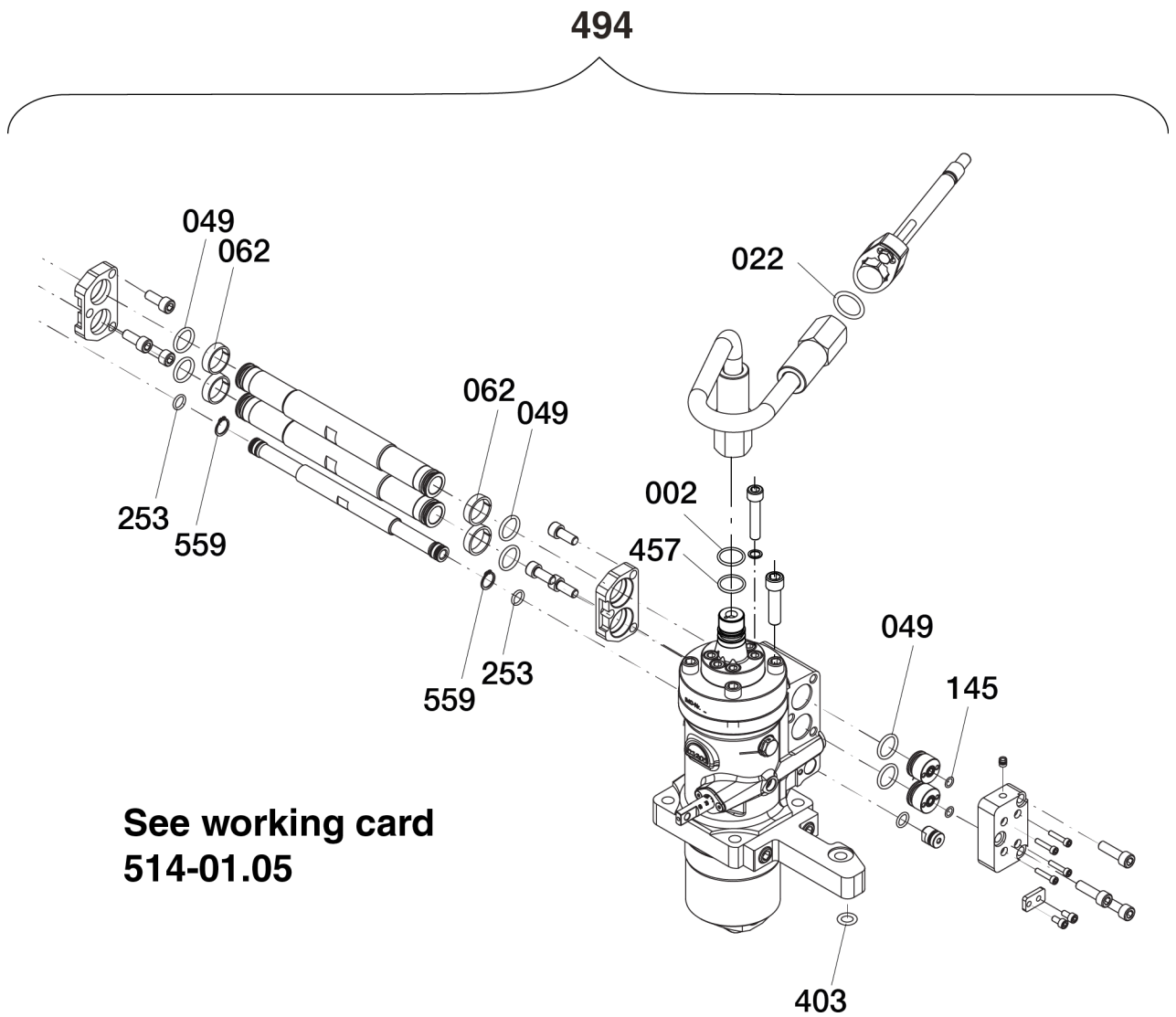

P51732-12	Kit for fuel injection pump connections	Spare Part Kit Plate Page 2 (2)
-----------	--	------------------------------------

L21/31, L21/31S

Item No.	Qty	Item Designation	Where to find in the engine instruction book	
494 ¹⁾	1	Kit for fuel injection pump connections, complete consisting of:		
	9	Seal ring	P51401	002
	9	Support ring	P51401	457
	9	Seal ring	P51404	022
	38	Seal ring	P51435	049
	34	Support ring	P51435	062
	2	Seal ring	P51435	145
	19	Seal ring	P51435	253
	9	Seal ring	P51435	403
	18	Retaining ring	P51435	559

When ordering spare parts, see also page 500.50/600.50/Preface.

* = Only available as part of a spare parts kit/not available separately

Qty/E = Qty/Engine

Note

¹⁾ Please Note that this is a kit supply, and that any exceeding number of o-rings and gaskets are not accepted as return goods.